

Die äußeren Seiten des Anschlagprofils müssen fest am Korpus montiert sein und ganzflächig aufliegen.

The complete outer sides of the stop profile must be firmly fixed to the base.

Darstellung
Image **80%**

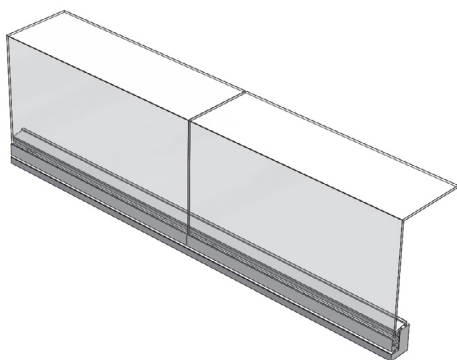

Kippbeschlag für senkrechtes Frontglas
max. Frontglasgröße L = 1250 mm H = 700 mm
max. Deckglastiefe T = 500 mm







Tilting armature for vertical counter
max. front glass size L = 1250 mm H = 700 mm
max. upper glass size T = 500 mm

Wir empfehlen ESG-Glas in allen Thekenaufbauten zu verwenden.

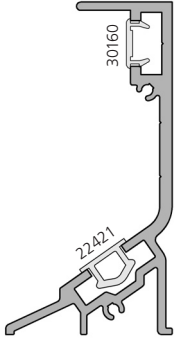
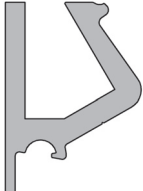
We recommend always toughened safety glass for all our systems.

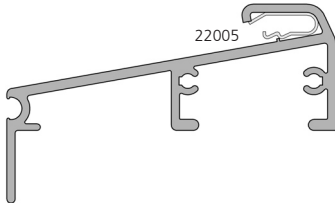
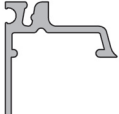
Kippbeschlag[®]
 Tilting armature[®]

224

	Anschlagprofil, Aluminium Stop profile	6000 mm	12230
	Glashalteprofil, Aluminium Glass holding profile	6000 mm Bohrabstand Bore distance 150 mm	12223
	Schraube M6 x 10 DIN 913 Screw M6 x 10 DIN 913	VPE 25 PU 25	SC003
	Klemmprofil, Aluminium Clamping profile	6000 mm	12224
	Preisschienenprofil, Aluminium Price-tag rail	6000 mm	12220
	Preisschienenprofil, Aluminium Price-tag rail	6000 mm	12225
	Einfassprofil, Weich-PVC transparent	3000 mm 6 mm Glas/glass	22411
	Bordering profile, Soft-PVC transparent	8 mm Glas/glass	22413
	Rundschnur, Weich-PVC Cord profile, Soft-PVC	Ø 4 mm	00535
	Abdeckprofil, Weich-PVC Covering profile, Soft-PVC	3000 mm	22421
	Abdeckprofil, PVC Covering profile, PVC	6000 mm	30160

Kippbeschlag[®]
Tilting armature[®]

224

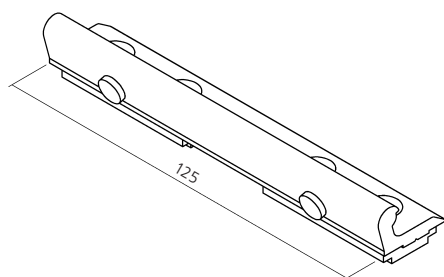

Kipplager mit Dämpfung
3 Stück / Glas
Tilting bearing with damping
3 pieces / glass

22410

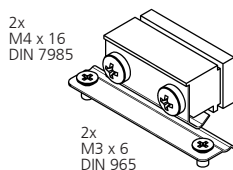

Arretierung
Locking mechanism

22400

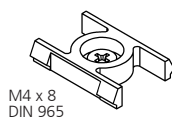

Verbindungsclip, Polyamid
Connecting clip, Polyamide

22405

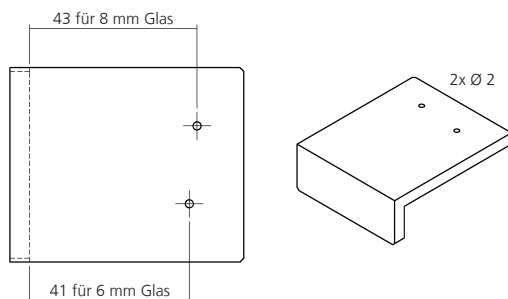

Bohrschablone - 12220
für Verbindungsclip 22405
Drilling jig - 12220
for connecting clip 22405

23481

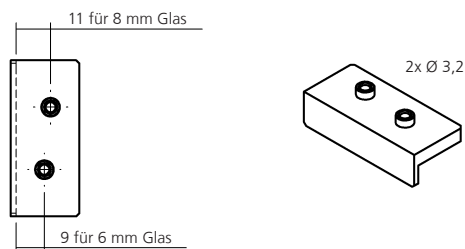

Bohrschablone - 12230
für Verbindungsclip 22405
Drilling jig - 12230
for connecting clip 22405

23482

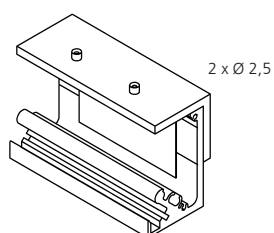

Bohrschablone - Gashalteprofil
für Arretierung 22403
Drilling jig - glass holding profile
for locking mechanism 22403

23483

Kippbeschlag[®]
 Tilting armature[®]

224

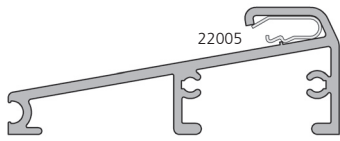

 Preisschienenprofil, Aluminium
 Price-tag rail

6000 mm

12219
 Klemmprofil, PVC
 Clamping profile

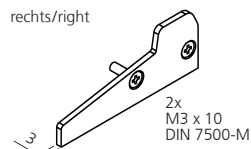
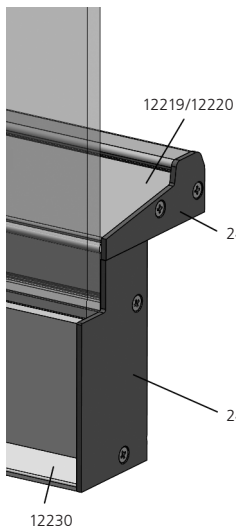
3000 mm

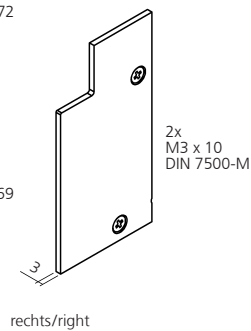
22005
 Endkappe, Aluminium
 für Profil 12219 / 20

 rechts/right
 links/left
24071**24072**
 End cap
 for profile 12219 / 20

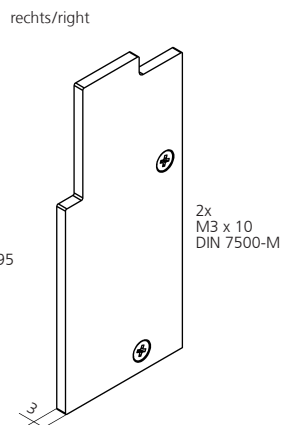
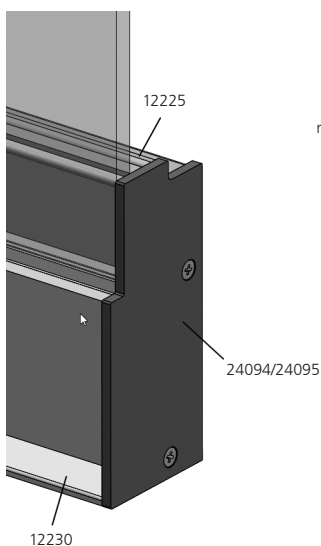
 Endkappe, Aluminium
 für Profil 12230

 rechts/right
 links/left
24068**24069**
 End cap
 for profile 12230

 Endkappe, Aluminium
 für Profil 12230 / 12225

 rechts/right
 links/left
24094**24095**
 End cap
 for profile 12230 / 12225